

# CSAMT Operation Manual



Prepare and plan the CSAMT layout .....	2
Setting up the site .....	10
Recording CSAMT Data .....	15
Viewing and Managing CSAMT Data .....	22
Appendix table of error codes -TXU-30 .....	36
Contact Support .....	46



# Prepare and Plan the CSAMT Layout

Equipment Required .....	3
Configuring Acquisition with EMpower.....	4
Frequency Transmission Schedule .....	6
Scalar CSAMT Layout Configuration .....	7

# Equipment Required

Transmitter Side	Receiver Side	General equipment	Tools & Supplies
<ul style="list-style-type: none"> <li>● TXU-30 or T3 transmitter and connecting cables               <ul style="list-style-type: none"> <li>○ Aluminium plates or Steel stakes for dipole</li> <li>○ Electric wires</li> <li>○ PE5 electrodes or steel stakes for grounding</li> </ul> </li> <li>● Remote Controller</li> <li>● CMU-1 <i>(only with TXU-30)</i></li> <li>● TXD-1 transmitter Driver               <ul style="list-style-type: none"> <li>○ SD Card</li> <li>○ GPS antenna and cable</li> <li>○ 12V Battery and Battery cable</li> <li>○ PE5 electrodes or Steel stakes for grounding</li> </ul> </li> <li>● 3 Phase Motor Generator               <ul style="list-style-type: none"> <li>○ Steel stake for grounding</li> </ul> </li> </ul>	<ul style="list-style-type: none"> <li>● Receiver</li> <li>● GPS antenna and cable</li> <li>● 12V Battery and Battery cable</li> <li>● Steel stakes or PE5 for dipoles and for grounding</li> <li>● E-line wires</li> <li>● Magnetic sensor and cable</li> <li>● SD Card with config file for each operation               <ul style="list-style-type: none"> <li>○ Receiver Calibration</li> <li>○ Sensor Calibration</li> <li>○ CSAMT recording</li> </ul> </li> </ul>	<ul style="list-style-type: none"> <li>● Configuration Layout Sheet</li> <li>● Laptop</li> <li>● EMpower + License <i>(v2.1 or above)</i></li> </ul>	<ul style="list-style-type: none"> <li>● Shovel and picks <i>(as needed)</i></li> <li>● Hammer, to install steel stakes</li> <li>● Container of salt water <i>(50 g/L)</i></li> <li>● Handheld compass</li> <li>● Measuring tape</li> <li>● Multimeters <i>(Analog and digital)</i></li> <li>● Pencil and permanent marker</li> <li>● Bubble Level</li> <li>● Wire cutters</li> <li>● Electrical tape / Flagging tape</li> <li>● Tarp</li> </ul>

# Configuring Acquisition with EMpower

1. Select the **Receiver Type** and choose **CSAMT** as recording type

## 2. Prepare CSAMT Setup Wizard

- Type the **Project name**
- Select the **Local power line frequency**
- Choose the **Local time zone**

## 3. Frequency Schedule

- Define the lowest and highest frequencies of interest (*Depending on target and operation*)
- Select the frequencies per octave for the project. A larger number gives a denser frequency spectrum at the expense of longer transmission cycles. Most common setting is 4.
- If necessary, click “View Table” to see the transmission schedule and suppress unwanted frequencies (see next page)

## 4. Transmitter Setup

- Select the **Transmitter Tx type**
- Type the **Sensor/ Tx serial number**
- For TXU-30 (external sensor)
  - Use the CMU-1 sensor Serial Number
- For T3 (*internal sensor*)
  - Type the serial number of the transmitter (*4 digits*)

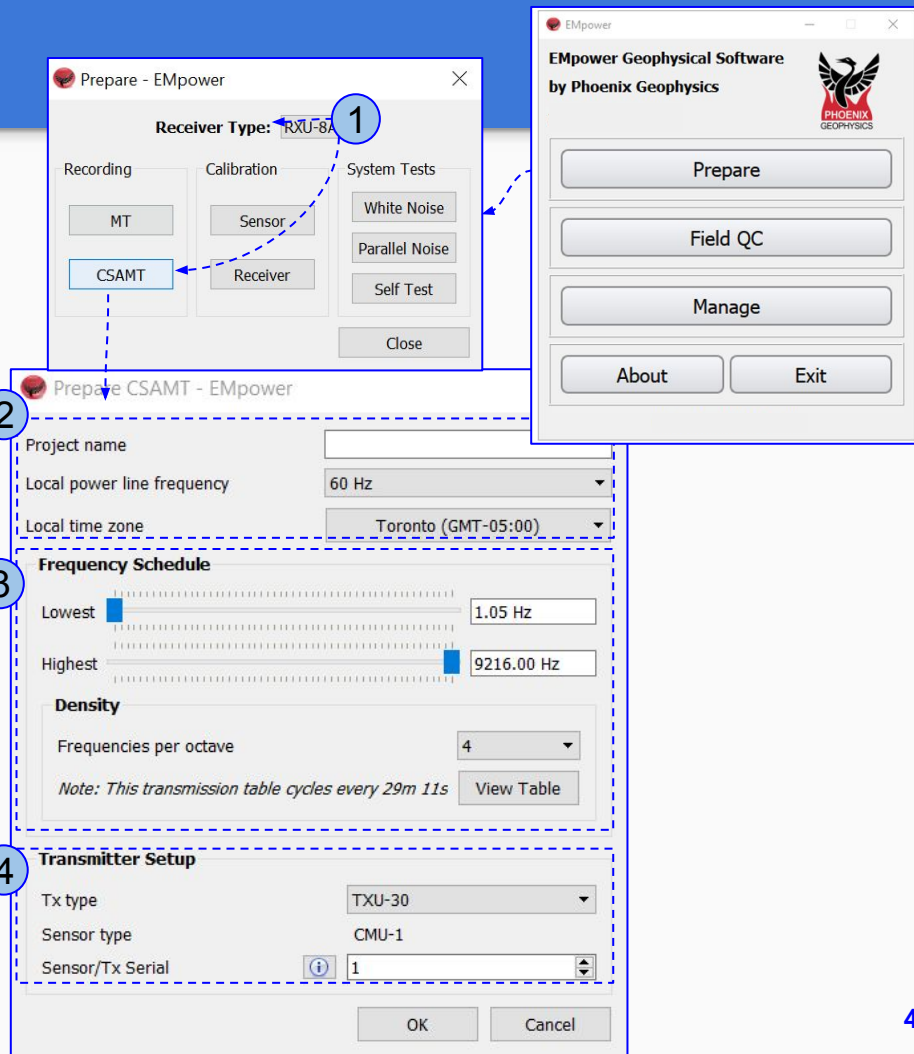

# Configuring Acquisition with EMpower-Frequency Transmission Schedule

The Frequency Transmission Schedule shows a table with the frequencies to be transmitted as per the density and range specified during configuration of the CSAMT schedule. The top of the form shows the number of frequencies being transmitted and the time needed to cycle through them all. The table also allows the user to selectively avoid a frequency or range of frequencies of a standard transmission schedule

**To Select** frequencies from the list for transmission, ensure that the checkbox is ticked on. All frequencies are selected by default.

**To skip** frequencies disable the corresponding checkbox. You may need to skip frequencies:

- When data acquisition time is limited, and there is a wide frequency band to measure. In this case you can skip some of the low frequencies to shorten the cycle duration.
- When the impedance of the transmitting dipole creates a resonance in the high power stage of the TXU-30, causing the transmitter to trip at a specific high frequency ([see: \*Troubleshooting TXU-30 - Error 21\*](#)).

Frequency Transmission Schedule - EMpo... X

Sampling rate: 24000 S/s  
Number of frequencies: 48  
Transmission cycle: Every 27m 56s

Frequency [Hz]	Duration [s]	
<input checked="" type="checkbox"/> 9216	12	Selected frequencies
<input checked="" type="checkbox"/> 8533.33	12	
<input checked="" type="checkbox"/> 7314.29	14	
<input checked="" type="checkbox"/> 6063.16	14	
<input checked="" type="checkbox"/> 5120	12	
<input checked="" type="checkbox"/> 4326.76	12	
<input checked="" type="checkbox"/> 3614.12	13	
<input checked="" type="checkbox"/> 3072	12	
<input type="checkbox"/> 2560	12	Skipped frequencies
<input type="checkbox"/> 2133.33	11	
<input type="checkbox"/> 1807.06	12	
<input type="checkbox"/> 1536	11	
<input type="checkbox"/> 1280	12	
<input type="checkbox"/> 1066.67	11	

# Configuring acquisition with EMpower Receiver Configuration

5. Define gain and Low Pass Filter for electric channels. Optimal values for CSAMT are:

**Gain:** Normal

**Low Pass Filter:** 10 kHz

6. Define the Electric **Dipole** length expected in the field, usually between 10 m to 200 m

7. Define the H1 **Magnetic Channel Settings**

7.1. Disable the magnetic channels (*H2 and H3*) that will not be used during acquisition (*Recommended*)

8. Review the **Frequency Transmission Schedule** (*see previous page*)

9. Fill in the **Configuration Layout**

10. **Save** the Config files

10.1. Select the number of receiver(s) of the same type

10.2. EMpower will create one configuration file for the transmitter driver (TXD) and one configuration file per receiver. Use one SD card per instrument.

\* SD cards are interchangeable for any equipment when using the same receiver type.

The screenshot displays the EMpower Configuration Creator software interface. The main window shows the configuration for an MTU-5C Broadband Receiver. The interface is annotated with numbered callouts (5-10) corresponding to the steps in the text. A physical receiver unit is shown in the center, with callout 7.1 pointing to the magnetic channel settings on its front panel. A 'Receiver Count Required' dialog box is open, showing '2' receivers. A 'Frequency Transmission Schedule' dialog box is also open, displaying a table of frequencies and durations. A 'CSAMT Config Save 1/3 - EMpower' dialog box is open at the bottom, with an information icon and a note about saving multiple files. The software interface includes a menu bar (File, Receiver, Schedule, Timezone), a toolbar (New, Load, Save), and various configuration panels for electric channel settings, magnetic channel settings, receiver settings, and configuration layout.

Configuration Creator - EMpower

File Receiver Schedule Timezone

New Ctrl+N  
Load Ctrl+O  
Save Ctrl+S

Electric channel settings

Enabled

Gain Normal

Low Pass Filter 10 kHz

Dipole 20.00 m

Magnetic channel settings

Enabled

Sensor Type MTC-155

Gain Normal

Low Pass Filter 10 kHz

Sensor S/H 0

Receiver Settings

Sampling rate: 24000

Frequencies: 53

Schedule: Cycles every 28m 56s

Power Recovery  Enabled

Configuration layout

Survey Name

Site Name

Operator(s)

Company Name

Configuration Notes

Receiver Count Required - ...

How many receivers are going to be used?

2

OK Cancel

CSAMT Config Save 1/3 - EMpower

For CSAMT, multiple files need to be saved. One for the transmitter driver, the others for the receivers.

Please ensure SD card 1 is inserted. When ready, click Ok and navigate to where you want to save the file.

Frequency Transmission Schedule - EMpo...

Sampling rate: 24000 S/s

Number of frequencies: 48

Transmission cycle: Every 27m 56s

Frequency [Hz]	Duration [s]
<input checked="" type="checkbox"/> 9216	12
<input checked="" type="checkbox"/> 8533.33	12
<input checked="" type="checkbox"/> 7314.29	14
<input checked="" type="checkbox"/> 6063.16	14
<input checked="" type="checkbox"/> 5120	12
<input checked="" type="checkbox"/> 4326.76	12
<input checked="" type="checkbox"/> 3614.12	13
<input checked="" type="checkbox"/> 3072	12
<input type="checkbox"/> 2560	12

# Scalar CSAMT Layout Configuration

## The controlled source recording grid

A grid is a set of lines arranged along two perpendicular imaginary axes which have their origin at a specific geocoordinate:

1. The **L** axis, along which the numeric ID of lines increases
2. The **S** axis, along which station numbers increase in numeric ID. All lines are parallel to this **S** axis (ideally)

The grid axes can be rotated via an azimuth angle, which is measured clockwise with respect to the magnetic north line, where the magnetic north is measured at the grid origin.

Each controlled source station recorded is located in reference to this grid.

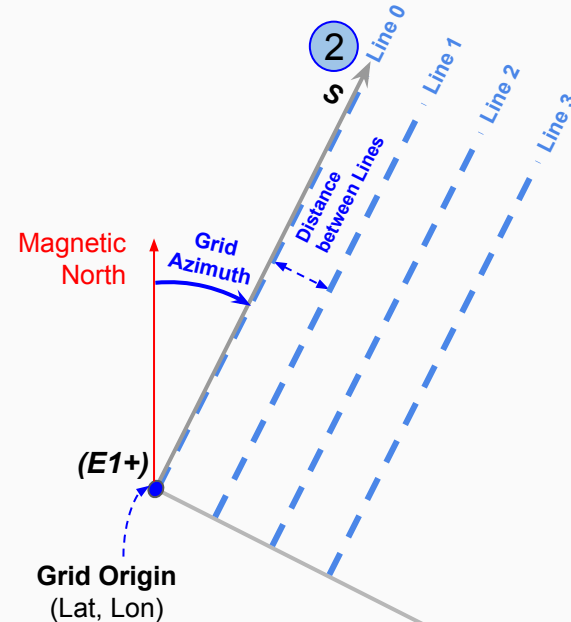

\*A **Grid Origin** is the geocoordinate of the first electrode (**E1+**) of the line. All station and line offset which use the same grid will be calculated using the distance from **Grid Origin**.

# Scalar CSAMT Layout Configuration

## Location of a scalar CSAMT station in a grid

A station is located at the centre of each dipole in scalar CSAMT surveys. Dipoles are installed on top of the lines defined in the grid.

1. A dipole is defined by the positive (+) and negative (-) electrodes connected to a channel (i.e channel  $E1$ ). The electrodes of a channel should be installed in the direction (+)  $\rightarrow$  (-) following the direction of the  $S$  axis.
2. “**Station Offset**” is located at the midpoint of each electrode couple. The position of a station offset is defined by **Line** and **Station** offsets. These are defined as the distance of the station from the **Grid Origin**, projected onto the  $L$  and  $S$  axes respectively.
3. The channels of a receiver should increase in the direction of the  $S$  axis. For instance, the station defined by  $E1$  should be installed closer to the origin than the station defined by channel  $E2$ .

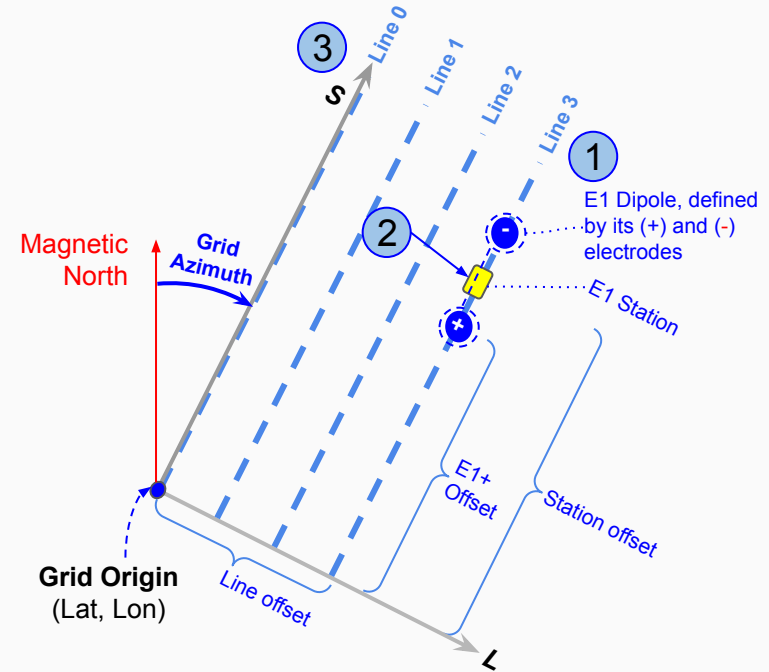

For convenience, EMpower lets users to define the location of stations based on first electrode position for each recording, which is easier to relate to the field layout



# Scalar CSAMT Layout Configuration

## Transmitter/Receiver layout considerations

1. If the geological strike is known, plan the survey lines and Tx dipole to be perpendicular to the strike direction as much as possible. In the field, try to keep the survey lines as parallel as possible to Tx dipole to maximize coupling.
2. Minimum Tx-Rx distance is controlled to avoid extreme “Near-field” effect, which is related to ground resistivity and to lowest frequency of interest
3. Maximum Tx-Rx distance can be as far as the signal strength is strong enough to record acceptable CSAMT data
4. Signal strength depends on Tx current, ground resistivity, frequencies, Tx dipole length
5. Rx E-dipole length ranges between 10 m to 200 m, depending on lateral resolution requirement and on productivity
6. Ensure to use the same polarity for Transmitting and for Receiving dipoles (*reverse polarity can be corrected later in EMpower*)

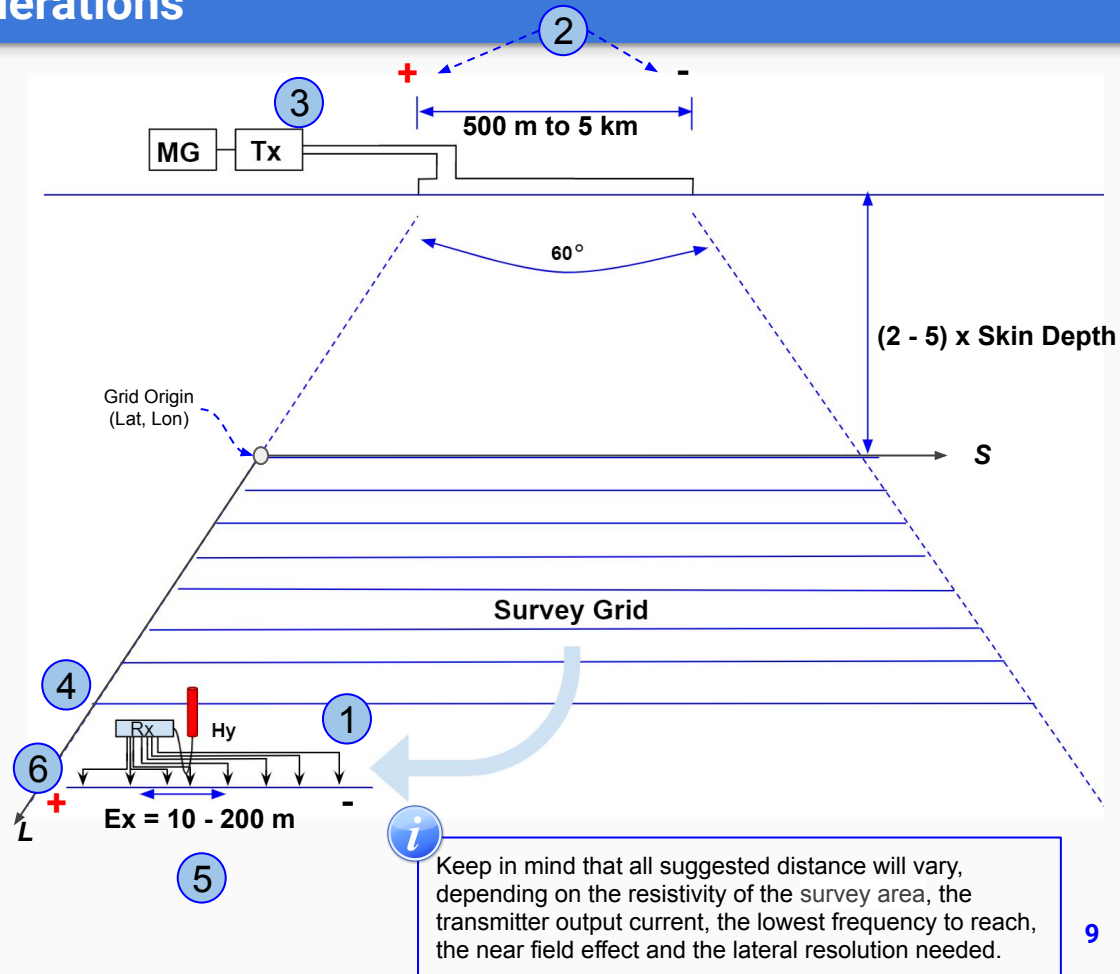



## Setting up the Site

Connections on the Transmitter side .....	11
Connection options for receiver layout .....	12
Working with more than one receiver .....	14



# Connection options for receiver electrode layout - RXU-8A

Select electrode locations that form 5 adjacent dipoles measuring the same length, and choose one of these two options

## Option 1 (Independent electrodes)

1. All posts of all channels are connected to an electrode. All electrode holes in the middle use a double electrode
  - Electrodes sharing a location should be installed a few cm apart without altering the dipole length
  - To avoid electrodes layout or connection mistakes, follow the drawing instructions

## Option 2 (Shared electrodes)

1. Six binding posts are connected to electrodes (not counting the ground). To share electrodes, the binding posts between central channels are bridged with wire as per the illustration
  - To avoid mistakes with electrodes layout or connections, follow the instructions in the drawing

### Option 1

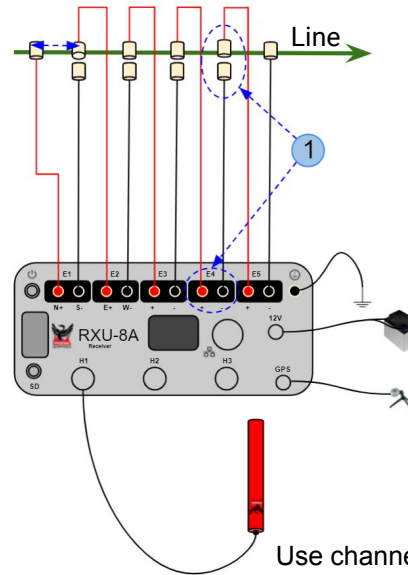

Use channel H1 and disable channels H2 and H3.

### Option 2

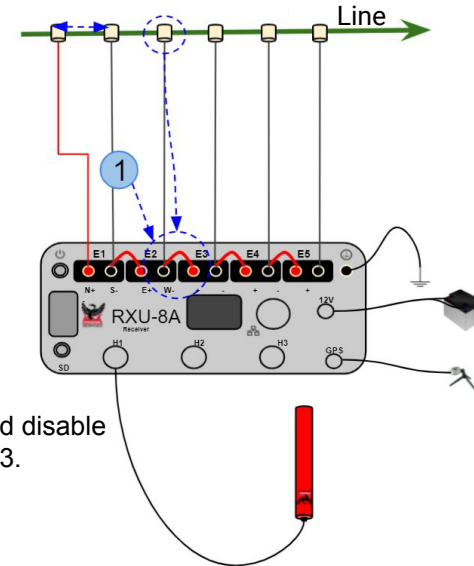

The spacing shown between electrodes in these drawings is not to scale

# CSAMT Connection MTU-5C / MTU-8A

As shown in the image, the CSAMT connection layout guidelines previously shown for RXU-8A can work using any receiver type.

Ensure that the configuration files for all receivers and for the TXD-1 are generated at the same time. This will ensure that they are using the same transmission frequency schedule

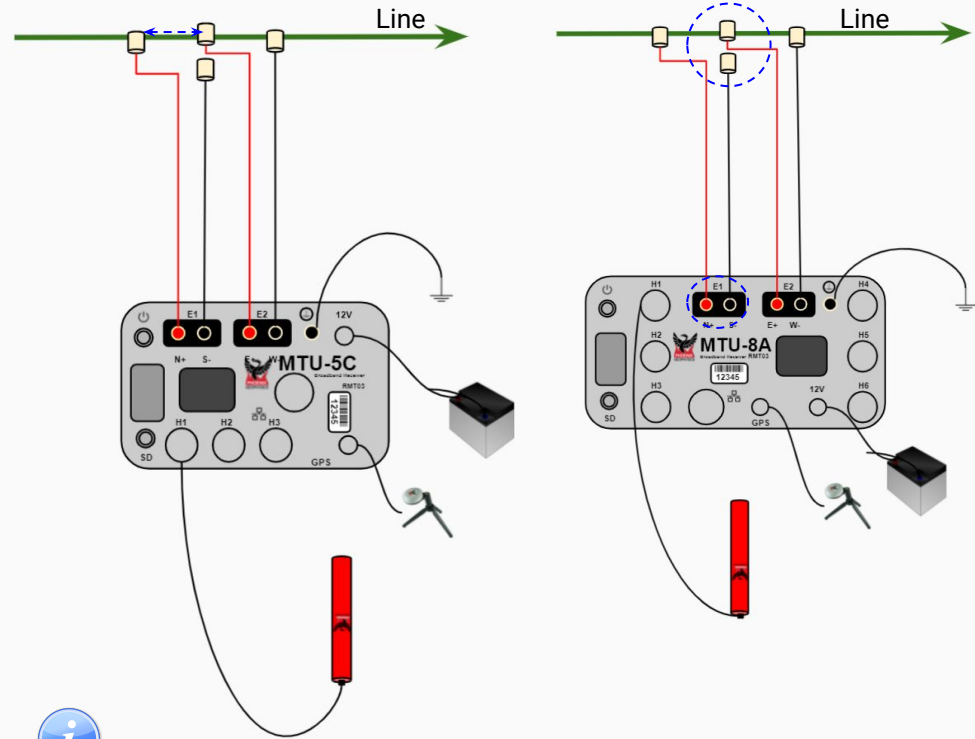

These drawings show one connection option only. See the [Connection options](#) page for more information

# Working with more than one receiver

1. To work with more than one receiver, follow the correct connection, using the **Option 1** ([See connection options page](#))
2. Following the drawing instructions, use the E5 (-) spot (Receiver 1) to install the electrode E1(+) (Receiver 2)

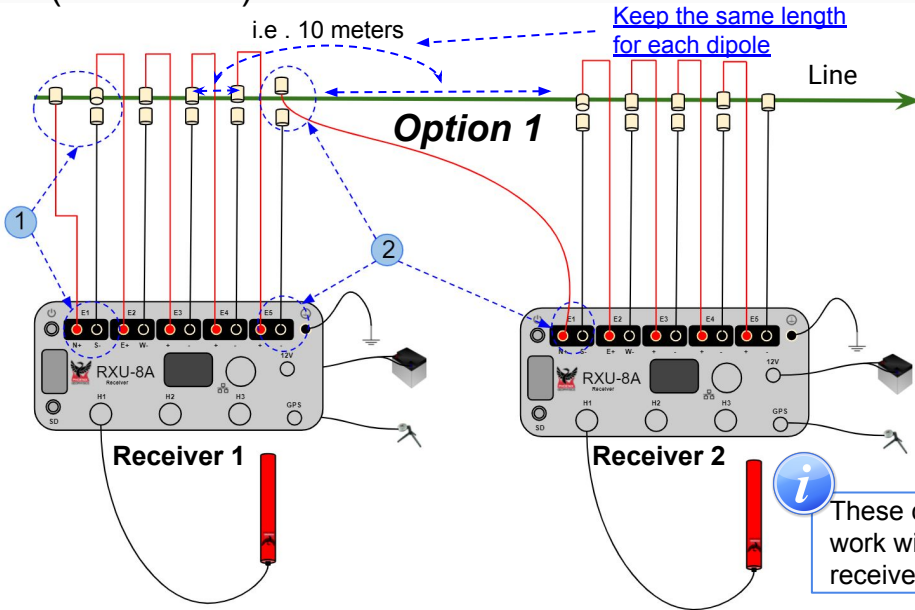

1. To work with more than one receiver, follow the correct connection, using the **Option 2** ([See connection options page](#))
2. Following the drawing instructions, use the E5 (-) spot (Receiver 1) to install the electrode E1(+) (Receiver 2)

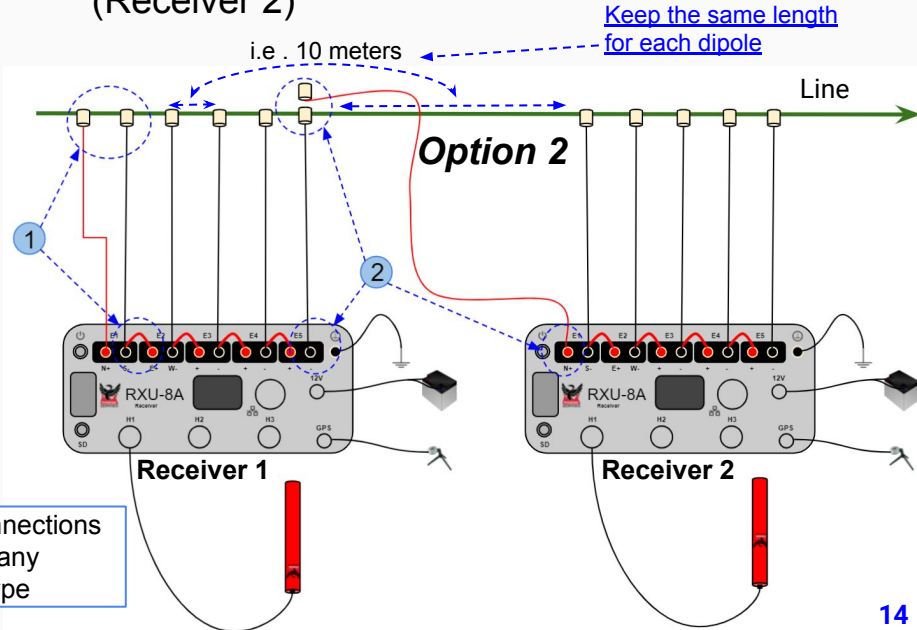

**i** These connections work with any receiver type



# Recording CSAMT Data

General Workflow .....	16
Recording CSAMT Data - Transmitter setup ..	17
Receiver operations .....	19
Stopping High power transmission.....	21

# Recording CSAMT Data - General Workflow

To record CSAMT data, you would normally have two types of the crew, one operating the transmitter, and one or many other crews operating the receivers. In this case, a normal survey day sequence would be as follows:

1. The transmitter crew installs the transmitter and starts transmitting a high power signal
2. Each receiver crew installs their recorder in predetermined stations and waits for the transmitter crew to indicate that transmission is running
3. When the transmitter is confirmed to be transmitting, receiver crews start recording data.
  - If a receiver crew has time, it moves to the next location and performs a recording at new stations while the transmitter is still working.
4. At a certain point, the receiver crews stop recording and pack up.
5. Only when all receivers have stopped recording, the transmitter is turned off.



# Recording CSAMT Data - Transmitter setup

## Setup the motor generator (MG)

Use a 3-phase MG, and connect the provided cables (x3) to the TXU-30

## Setup the TXU-30 panel

Ensure the output switch is **OFF** and set the Voltage Range switch to the maximum output mode desired:

- Low: 500 V mode
- Hi: 1000 V mode

## Turn on the equipment, in the following order

- A) TXD-1 Transmitter Driver    C) TXU-30
- B) Motor generator                D) Remote Controller

## Setup the Remote Controller

- Push Select (1) until MODE is flashing
- Turn the wheel (2) to set MODE to “EXTCLK”
- Push Select (1) until CURRENT is flashing
- Turn the wheel (2) to set CURRENT to the desired value
- Push Select (1) until VOLTAGE is flashing
- Turn the wheel (2) to set VOLTAGE to the desired value, ensure keeping this value within the max Voltage Range set in the panel as done above (which can be either 500 V or 1 kV)

**Note:** TXU-30 automatically sets the voltage depending on the desired CURRENT value

Transmitter crew installs transmitter and starts transmitting high power signal

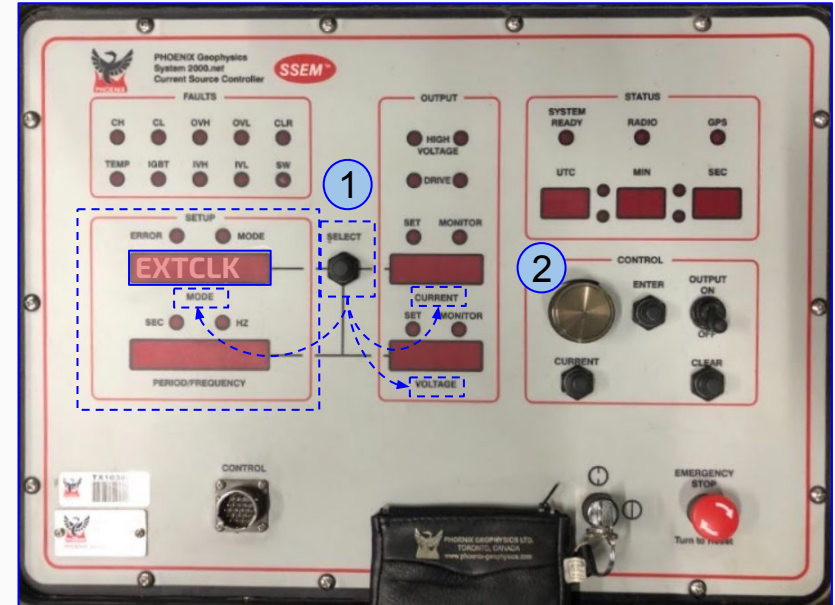

Before start, check the contact resistance of the Tx dipole to ensure that there are no connection problems

## Generating and recording a frequency waveform

- Start the waveform generation and current recording by pressing the power button of the TXD-1 Transmitter Driver when both of its LEDs are solid blue
- When both LEDs are flashing blue, the TXD-1 Transmitter Driver is generating a waveform and recording the transmitter current, you can now proceed to turn on the output of the transmitter

## Turning on the high power output

- Set the **OUTPUT** switch of the Remote Controller to the **ON** position to start transmitting
  - Be extremely cautious at that point with the Tx E-dipole, **DO NOT TOUCH** any steel stakes or plates while injecting current
  - The Remote Controller will display the actual output current and voltage
    - *The actual value might be different than desired value due to limitations imposed by the load*
    - *In case of receiving an error in the TXU-30 remote when turning on the power, consult your TXU-30 user manual to understand how to deal with it.*

# Recording CSAMT Data - Receiver operations

Once the transmitter is confirmed to be transmitting, the crews will start the receiver installation

1. Install the receiver
  - Consult section “Connection options for receiver electrode”
  - Insert the SD Card
2. Turn on the **receiver**
3. Start recording data by pressing the power button after both LEDs are solid blue
4. Complete the full frequency cycle (*CSAMT recording in progress*)
  - Full frequency cycle is ~30 min (4 frequency per octave)
    - \*It will depend on the frequency range and number of frequencies per octave
  - Recording additional cycles will increase the number of clean stacks for noisy areas

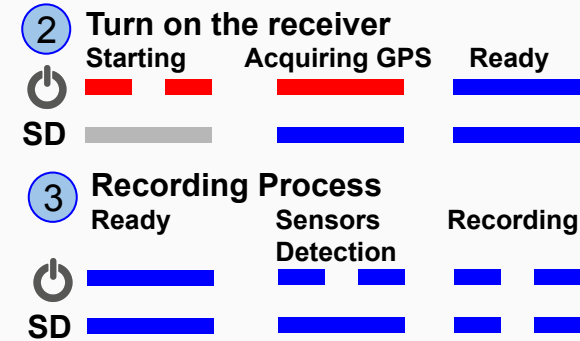

! Stop the receiver(s) recording before turning off the transmitter.

The current reported in the TXD screen will be "peak" current as opposed to RMS or other measurement techniques. This is indicated in the receiver screen by "pk" after the current measurement. For certain frequencies, there can be an inductive/aliasing effect. The reported current will be slightly different than the current reported in the TXU controller due to this effect.

\* Note that in some cases the current and reported on the screen may be delayed by approximately 20-30 seconds because of the calculation routines that the TXD uses.

# Recording CSAMT Data - Receiver operations

5. Stop the recording after the acquisition is complete by pressing the power button
6. Move the sites and repeat steps 1 to 5 at the next location. During the procedure, it is not necessary to turn off the transmitter.
  - Use a small battery in the side pouch of the instrument's bag, and hang the GPS antenna on the other pouch. This allows keeping the receiver ON while moving the receiver to a new location, and start recording without having to wait for GPS
7. At the end of the day, after stopping the last recording, turn off the receiver by pressing the power button for more than 3 seconds

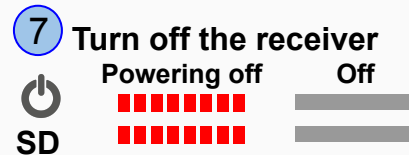
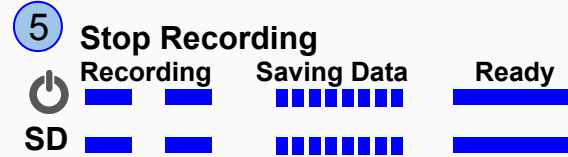

# Stopping High power transmission - Transmitter side

At the end of the day, and after confirming that all receiver crews have stopped recording, follow this process to correctly turn off the transmitting equipment:

1. Set the **OUTPUT** switch of the **Remote Controller** to the **OFF** position to stop the high power output of the **Transmitter**.
2. Stop the **TXD-1** transmitter Driver recording by pushing the power button briefly
  - 2.1. Turn off the transmitter by pressing the power button
3. Turn off the **TXU-30** by setting the output switch in the TXU-30 panel to OFF
  - o Wait until the TXU-30 cools down (*when fans stop*)
  - o Turn off the **Motor Generator**

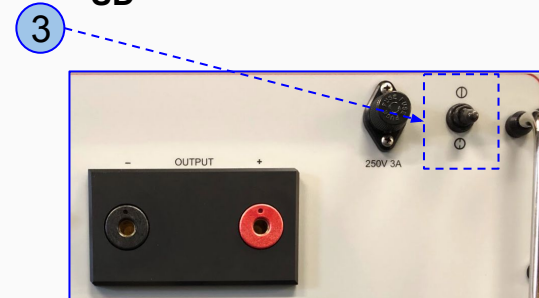
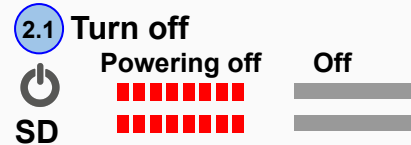
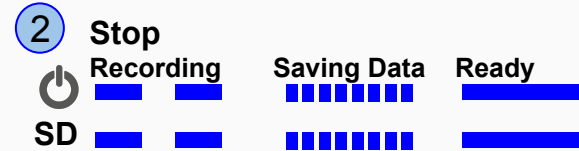
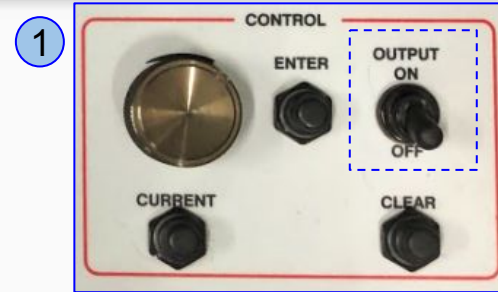



# Viewing and Managing CSAMT Data

Field QC .....	23
Field QC Edit Station( <i>Station Naming</i> ) .....	24
Managing a CSAMT survey .....	25
Grid settings - The default grid .....	26
Grid settings - Single grid .....	27
Grid settings - Multiple grids .....	28
CSAMT Station Editor .....	29
Edit Station - Auto-naming Stations .....	30
Editing Station Locations .....	31
Editing Metadata for Multiple recordings ....	33
Stack rejection tool .....	34
CSAMT Processed Data Exporter .....	35

# Field QC

Use **Field QC** to quickly check the results obtained in the field

1. From **Field QC**, click **View Data** button and select the recording from SD Card or from data directory
2. Review the Recording Information and edit the station layout if necessary (*as per next page*)
3. Review the curves on **Time Series** and **Spectra**
4. Review the results by clicking the **View CSAMT Results** button
5. To keep track of the quality of the recording as observed in the field, it is recommended to either set the recording **Status** as as accepted or rejected

**EMpower Geophysical Software**  
by Phoenix Geophysics

Prepare  
Field QC  
Manage

**Field QC - Selection - EMpower**

- View data: Check quality of acquired data
- View calibration: Generate and view calibrations
- Monitor receiver: Monitor receiver status in real-time
- View self-test results: Check results of receiver channel tests

**Field QC - EMpower**

(1 h 6 m 7 s)

Status:  Approved  Unapproved  Rejected

Tools: Time Series Spectra **View CSAMT Results**

Recording Information

Recording ID: 10426\_2021-07-28-174548

Start time: Jul 28 2021 17:45:49 Eastern Daylight Time (GPS -04:00)

Duration: 1 h 6 m 7 s

Survey name: CSAMT TEST2 JULY21

Channel	Name	Length [m]	Station Offset [m]	Polarity	Resistance (+/-) (Ω)	Gain	LPF [Hz]	DC [V]
E1	L050	10	5	<input type="checkbox"/> Inverted	38.908 408.496	8 x 1 = x8	10000	0
E2	L051	10	15	<input type="checkbox"/> Inverted	413.362 446.137	8 x 1 = x8	10000	0
E3	L052	10	25	<input type="checkbox"/> Inverted	417.643 440.258	8 x 1 = x8	10000	0
E4	L053	10	35	<input type="checkbox"/> Inverted	433.429 417.230	8 x 1 = x8	10000	0
E5	L054	10	45	<input type="checkbox"/> Inverted	430.407 444.790	8 x 1 = x8	10000	0

Line Azimuth [°]: 0  Origin Point: 42.914°N 79.357°W  Edit Stations

Magnetic Channels

Channel: H1, H2, H3, H1-H3 Az

**View Recording**

LO: S0-S0 Receiver 10426 (Evaluation)  
Jul 28 17:45:49 to Jul 28 18:31:56 GPS (1 h 6 m 7 s)

Amplitude [Fm] vs Frequency [Hz] plot showing curves for E1, E2, E3, E4, E5.

# Field QC - Edit Station (*Station Naming*)

To keep the data organized and fully reflecting the actual station names, Phoenix recommends reviewing and **Editing Station's** Name and actual dipole length in the **Field QC** module after each acquisition.

1. Use the **Edit Station** button in Field QC to rename stations

## 2. Auto Station Naming

Used to rename stations to the standard "L<line#>S<station#>", where the number in the **S** field corresponds to the first channel in the table

**Note:** After importing data to EMpower project, EMpower will show CSAMT Stations on the map at their correct name as edited in the Field QC module.



For Mac users, after editing any fields hit the "enter/return key" on the Keyboard before clicking on the Save button of the **CSAMT Station Editor** window in order to save changes.

Channel	Name	Length [m]	Station Offset [m]	Polarity	Resistance (+/-) (Ω)	Gain	LFF [Hz]	DC [V]
E1	E1	10	5	<input type="checkbox"/> Inverted	384.590 351.197	8 x 1 = x8	10000	0
E2	E2	10	5	<input type="checkbox"/> Inverted	367.253 392.039	8 x 1 = x8	10000	0
E3	E3	10	5	<input type="checkbox"/> Inverted	375.133 387.554	8 x 1 = x8	10000	0
E4	E4	10	5	<input type="checkbox"/> Inverted	382.844 371.561	8 x 1 = x8	10000	0
E5	E5	10	5	<input type="checkbox"/> Inverted	382.940 400.030	8 x 1 = x8	10000	0

Line Azimuth [°]: 0    Origin Point: 79.357°W    **1** Edit Stations

Grid setup

Selected Grid:

**2** Auto Station Naming

L: 0    S: 0

Rename stations

Channel ID	Station Name	Dipole Length [m]
E1	E1	20
E2	E2	20
E3	E3	20

Auto Station Offset Calculator

Line Offset [m]: 0

E1+ Electrode Offset [m]: 0.00

Grid setup

Selected Grid:

Auto Station Naming

L: 0    S: 0

Rename stations

Channel ID	Station Name	Dipole Length [m]
E1	L0S0	20
E2	L0S1	20
E3	E3	20

Auto Station Offset Calculator

Line Offset [m]: 0

E1+ Electrode Offset [m]: 0.00

Cancel    Save



# Managing a CSAMT survey

The Manage section of EMpower can be used to aggregate and manage the data of all stations in a survey project through easy-to-use visual tools. To open a project, follow these steps:

1. Start **EMpower**
2. Click **Manage** module
3. Open or Create a Project

## Existing Project

- Select from the list (*previously used*) and click **Open**
- Or
- Click **Find Existing Project**
- Select the Project

## New Project

- Click **New**
- Type the Project Name

4. Click **Choose**

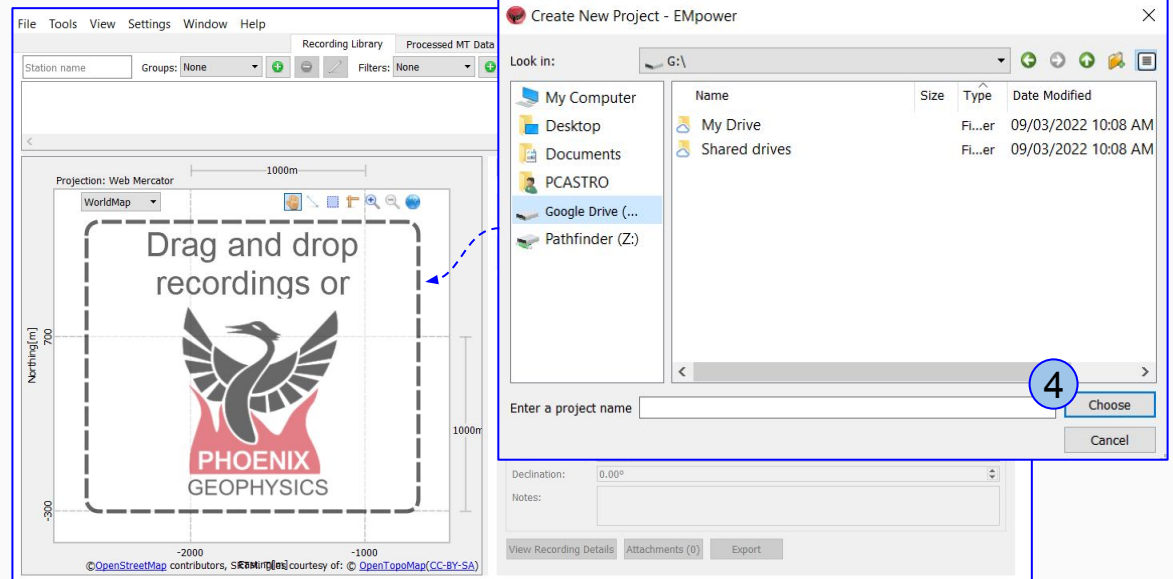
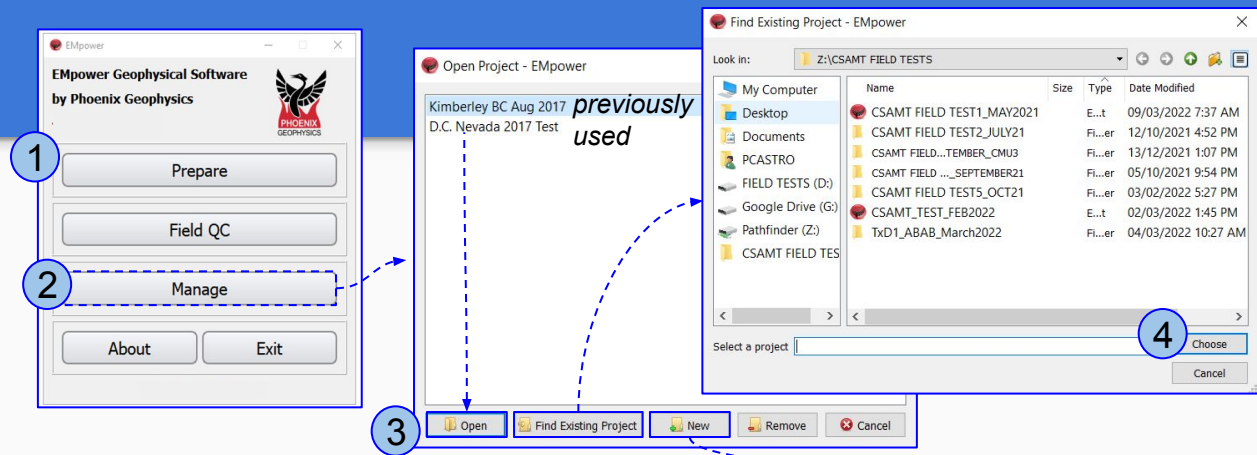

# Grid settings - The default grid

A new CSAMT project will require one or more grids to locate the stations imported into the map.

1. All stations imported to the project will be automatically assigned to the active default grid. The first grid created will automatically become the default Grid.
  - All recordings that are not yet assigned to a grid, will get assigned to the default one as soon as it is created
  - Consult page 6 for more details about the Grid Azimuth and Grid Geocoordinate origin conventions
2. When there is more than one grid in the project, the default grid has to be explicitly set, to ensure that new recordings get assigned to the desired grid
3. The default grid can be changed at any time. This will assign any recording imported from there on into the new default grid
  - To set the active default grid, select the desired grid, click “Set Default” and save.

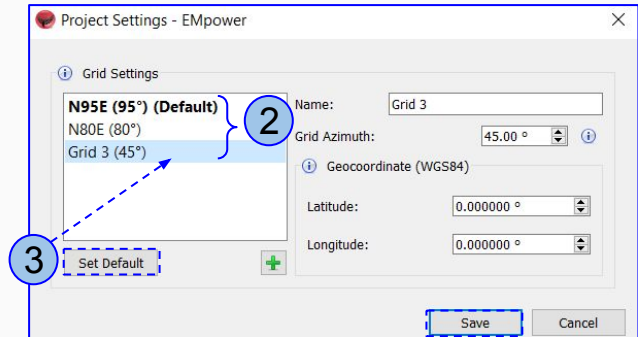
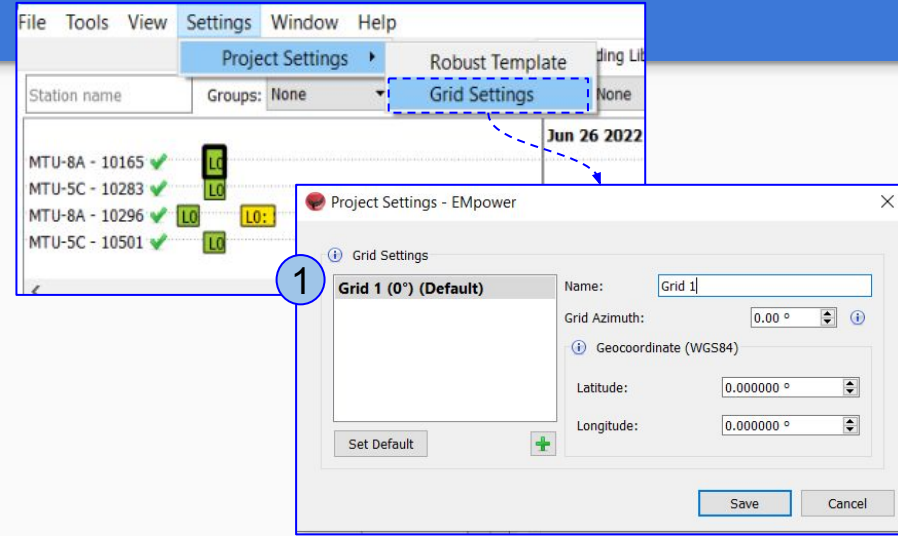

*Note that each recording can be manually switched from one grid to another whenever needed. The location of a recording in the map is set using the **CSAMT Station Editor**.*

# Grid settings - Single grid

Optimal when the stations are all installed in lines that are parallel to each other

1. In the main menu of the Manage section select *Project Settings / Grid Settings*

1.1. To add a grid, click the  icon, type the **Name** to identify that particular grid, type the **Grid Azimuth** and the **Geocoordinate** of the origin of the grid (see slide 6), and **Save**

*Note: The first grid created will be the Default Grid to locate all recordings imported to the project*

*\*If there is a line with a different orientation, users need to create a new grid using a new grid origin and line azimuth as described in the following slides.*

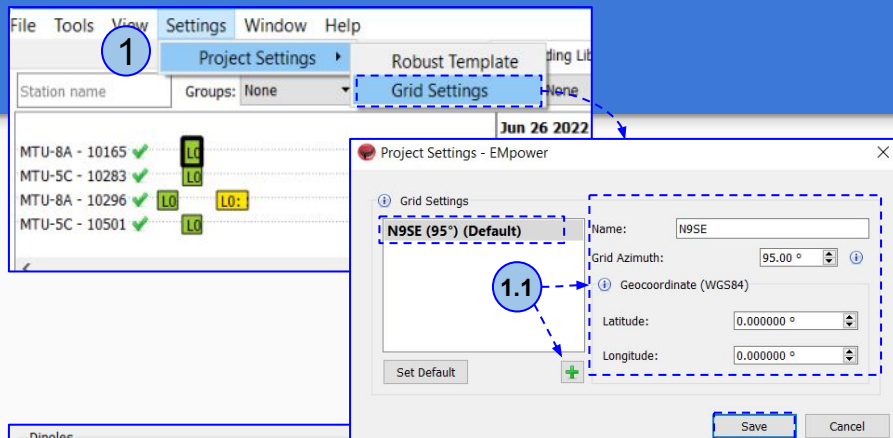

Project Settings - Grid Settings

Name: N95E

Grid Azimuth: 95.00 °

Geocoordinate (WGS84)

Latitude: 0.000000 °

Longitude: 0.000000 °

Buttons: Set Default, Save, Cancel

Dipoles

Channel	Name	Length [m]	Station Offset [m]	Polarity	Resistance (+/-) (Ω)
E1	L3S0	20	10	<input type="checkbox"/> Inverted	1446.928 2.348
E2	L3S1	20	30	<input type="checkbox"/> Inverted	4.889 844.247

Line Azimuth [°]: 80 | Origin Point: 37.338°N 114.941°W | [Edit Stations](#)

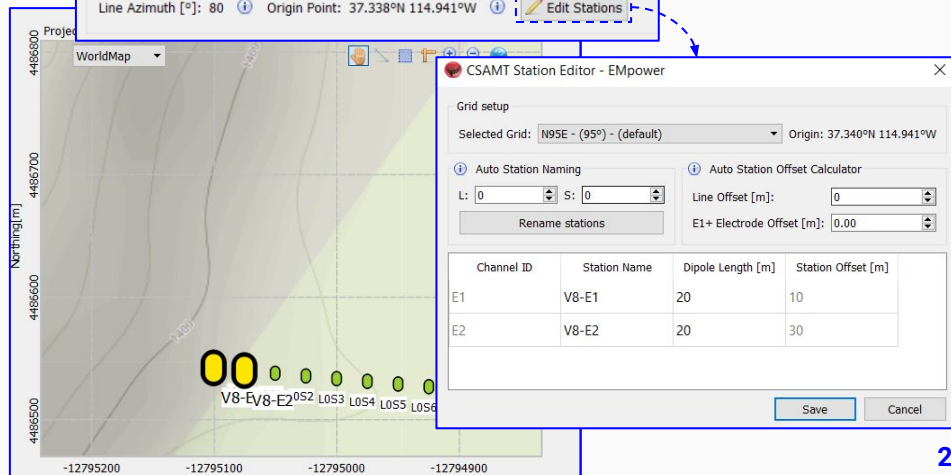

CSAMT Station Editor - EMpower

Grid setup

Selected Grid: N95E - (95°) - (default) | Origin: 37.340°N 114.941°W

Auto Station Naming: L: 0 | S: 0

Auto Station Offset Calculator: Line Offset [m]: 0 | E1+ Electrode Offset [m]: 0.00

Channel ID	Station Name	Dipole Length [m]	Station Offset [m]
E1	V8-E1	20	10
E2	V8-E2	20	30

Buttons: Save, Cancel

# Grid settings - Multiple grids

Multiple grids can be used for different advanced mapping purposes:

- Mapping stations in projects that have lines with different azimuths.
- Mapping projects that have stations installed in several separate geographical locations.
- Also, one grid can be used per line if that makes mapping easier.

## Example of lines with different azimuths:

1. The map shows stations in lines L0 and L1 positioned using a grid with a 95° azimuth, with origin coinciding with L0S0
2. The stations in line L2 use a second grid that has an 80° azimuth, with its origin coinciding with L2S0

The image displays the EMpower software interface with several windows open. A map in the background shows station locations L0S0 through L2S7. Two windows are highlighted with blue boxes and numbered 1 and 2.

**Window 1: Project Settings - EMpower**

- Grid Settings: N95E (95°) (Default)
- Name: N95E
- Grid Azimuth: 95.00 °
- Geocoordinate (WGS84): Latitude: 37.339507 °, Longitude: -114.940501 °

**Window 2: CSAMT Station Editor - EMpower**

- Grid Setup: Selected Grid: N95E - (95°), Origin: 37.340°N 114.941°W
- Auto Station Naming: L: 0, S: 0
- Auto Station Offset Calculator: Line Offset [m]: 0, E1+ Electrode Offset [m]: 0.00
- Table:

Channel ID	Station Name	Dipole Length [m]	Station Offset [m]
E1	L0S0	20	10
E2	L0S1	20	30

**Window 3: Project Settings - EMpower**

- Grid Settings: N80E (80°) (Default)
- Name: N80E
- Grid Azimuth: 80.0
- Geocoordinate (WGS84): Latitude: 37.33792, Longitude: -114.940

**Window 4: CSAMT Station Editor - EMpower**

- Grid Setup: Selected Grid: N80E - (80°) - (default), Origin: 37.338°N 114.941°W
- Auto Station Naming: L: 2, S: 0
- Auto Station Offset Calculator: Line Offset [m]: 0, E1+ Electrode Offset [m]: 0.00
- Table:

Channel ID	Station Name	Dipole Length [m]	Station Offset [m]
E1	L2S0	20	10
E2	L2S1	20	30

# CSAMT Station Editor

The CSAMT **Edit Stations** button opens the **CSAMT Station Editor**. This editor allows setting an ID for the recorded stations, and offers mechanisms for mapping such stations within a grid, based on the dipole lengths used in the field.

To facilitate these tasks, the station editor offers different automated tools

1. **Auto Station Naming** (see pages 30)
2. **Auto Station Offset Calculator**

**Note:** After importing data to EMpower project, EMpower will show CSAMT Stations on the map, either at their recording GPS location if no grid has been selected, or at their position as defined by the grid and the Offset Calculator.

**CSAMT Station Editor - EMpower**

Grid setup  
Selected Grid: **grid\_1 - (45°) - (default)** Origin: 0.000°S 0.000°E

Auto Station Naming  
L: 0 S: 0

Auto Station Offset Calculator  
Line Offset [m]: 0  
E1+ Electrode Offset [m]: 10.00

Channel ID	Station Name	Dipole Length [m]	Station Offset [m]
E1	L0S0	100	60
E2	L0S1	100	160
E3	L0S2	100	260

Save Cancel



For Mac users, after editing any fields, hit the "enter/return key" on the Keyboard before clicking on the Save button of the **Edit Station** window in order to save changes.

# CSAMT Station Editor - Auto Station Naming

To use the standardized station naming convention in EMpower, follow these steps:

1. On top of the table, type the **L** (line) and **S** (station) numbers that correspond to the first dipole in the recording (*i.e.* E1).
2. Click **Rename stations** to rename all stations in the format “L<line#>S<station#>” and then click **Save**.

**Note:** The processed CSAMT data tab will reflect changes done by the auto-naming tool automatically.

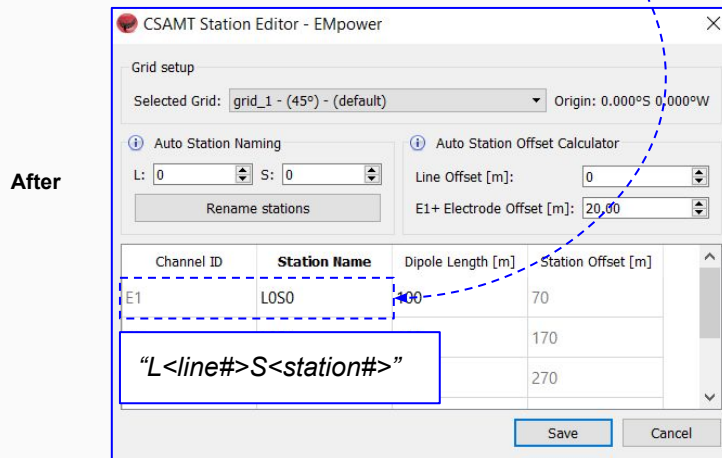
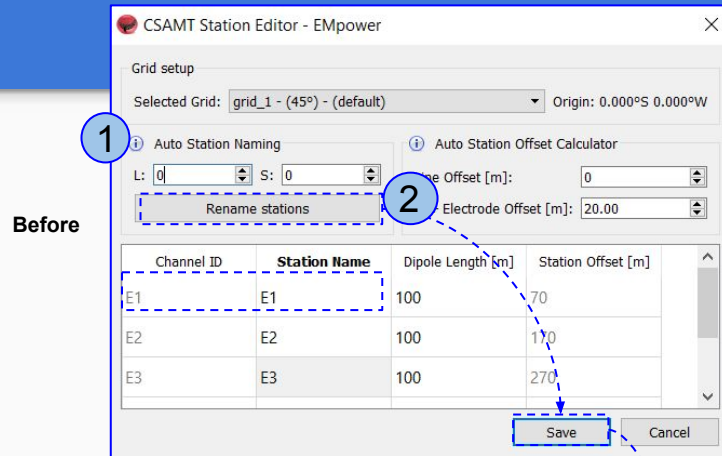

# CSAMT Station Editor - Editing Station Locations

To correctly locate each dipole in the map grid, use the **Edit Stations** button (*Recording Information / Recording library*)

1. Select the Grid that this recording belongs to  
*\*To create a new Grid, see pages 25-27*
2. Ensure that all dipole lengths in the table match the lengths used during the survey. If the lengths differ, double click on the **Dipole Length** cell of the station(s) that need to be updated and change the length
3. Type the **Line Offset** of the line of the dipole, measured from the **S** axis in the direction of the **L** axis
  - 3.1. Type the **E1+ Electrode Offset**, which is the offset to the positive electrode of the first station in this recording (i.e. the one recorded by channel E1) in the direction of the line.
4. Click **Save**



Refer to pages 6 and 7 in this manual for more information about axes **S** and **L**, on locating a station within a grid using offsets, and the standard way of ordering receiver channels within a line.

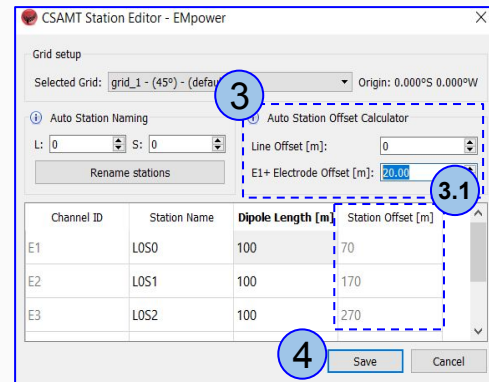
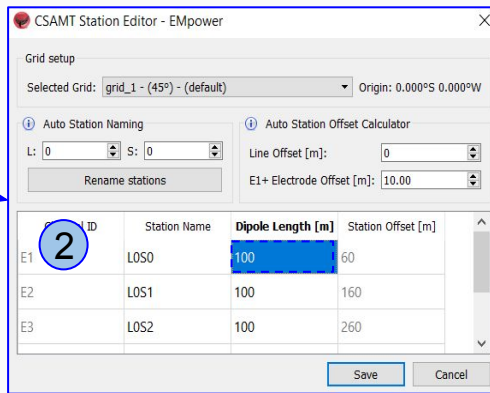
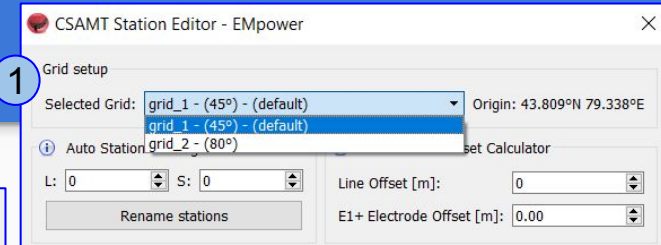
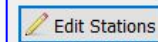

# Borrowing a magnetic channel

EMpower allows to process CSAMT data by using a different magnetic channel from either the same receiver or by borrowing magnetic channel data from another nearby receiver which acquired CSAMT data simultaneously.

This tool can be used:

- When the magnetic channel data is corrupted or noisy
- To reduce time and costs in the field by using a single magnetic sensor for several receivers.

1. Use the **Change Magnetic Source** button to change the magnetic sensor

2. The **CSAMT Magnetic Sensor Selector** window shows the available magnetic channels

2.1. Change the default sensor to another magnetic channel of the same recording and click the **Save** button

Or

2.2. Choose the magnetic channel from a concurrent receiver and click the **Save** button

3. Review the changes on the **Processed CSAMT Data** tab

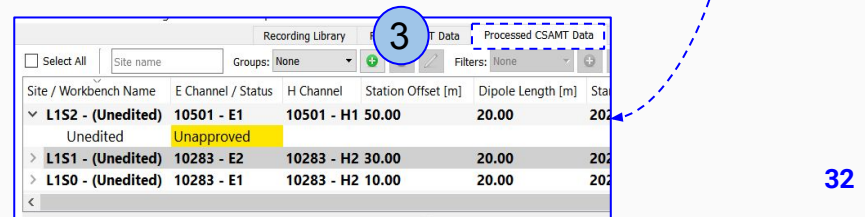
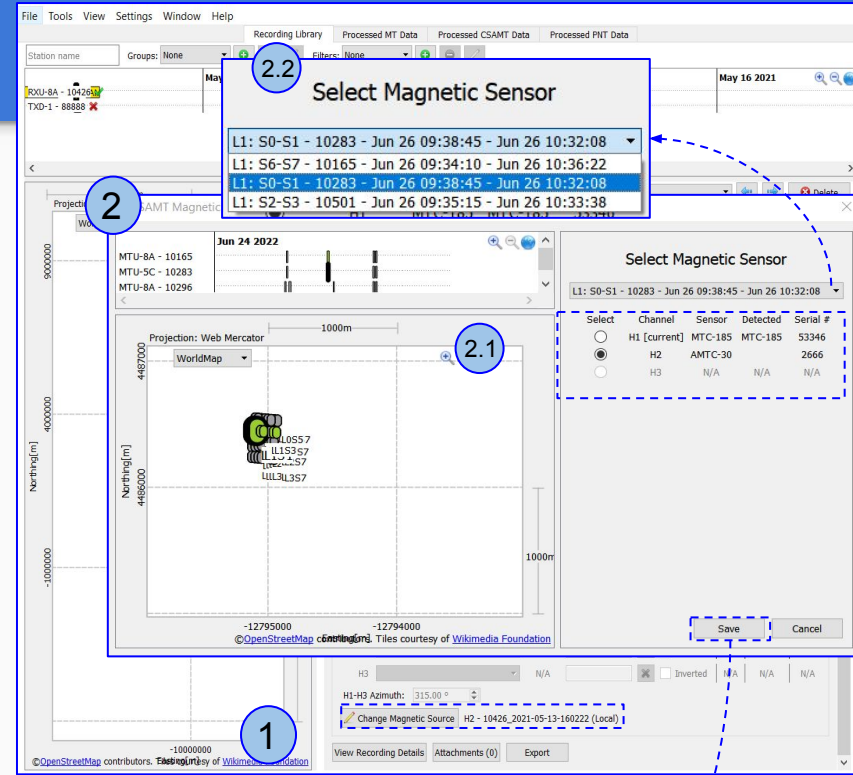



# Editing Metadata for Multiple Recordings

Use the **Multi-Rec-Edit** tool to update or adjust the metadata of multiple recordings at once. To do so, follow these steps.

1. From the **Tools** menu select the **Multi-Rec Edit** option
2. Select the filter for **CSAMT** recordings
3. Select the recordings that need to be edited
  - Left-click on the first desired site on the list, press and hold the Shift key and left-click on the last desired site
  - Or
  - Left-click on the metadata desired site on the list and hold Ctrl+left-click on any other stations desired
4. Edit the information as needed
  - Click **OK**

The screenshot shows the EMpower software interface. The main window is titled 'CSAMT TEST - MAY2021 (D:/CSAMT TEST - MAY2021) - EMpower'. The 'Tools' menu is open, and 'Multi-Rec Edit' is selected. The 'Multi Rec Editor - EMpower' dialog is open, showing a table of recordings. The 'Batch Editing - EMpower' dialog is also open, showing fields for Status, Survey Name, Operator(s), Company, and Declination.

Recording Information	Survey Name	Company Name	Operator	Status	Receiver Type	Instrument ID	Declination
10426_2021-05-13-160222	Test at Tims	Phoenix Geophysics		Unapproved	RXU-8A	10426	0
10426_2021-05-19-204847	Tims Test 2	Phoenix Geophysics	EE / MU / SS	Unapproved	RXU-8A	10426	0

The 'Batch Editing - EMpower' dialog shows the following fields:

- Status:  Approved,  Unapproved,  Rejected
- Survey Name: Test1
- Operator(s):
- Company:
- Declination: 0.00°

# Stack Rejection Tool

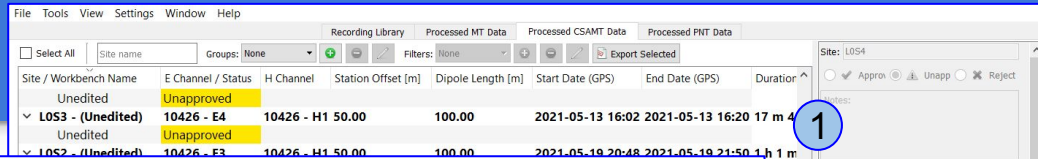

Site / Workbench Name	E Channel / Status	H Channel	Station Offset [m]	Dipole Length [m]	Start Date (GPS)	End Date (GPS)	Duration
Unedited	Unapproved						
LO53 - (Unedited)	10426 - E4	10426 - H1	50.00	100.00	2021-05-13 16:02	2021-05-13 16:20	17 m 4 s
Unedited	Unapproved						
LO52 - (Unedited)	10426 - E3	10426 - H1	50.00	100.00	2021-05-19 20:48	2021-05-19 21:50	1 h 1 m 2 s

The Stack editor is a tool designed to clean the data by removing the selected noisy stacks

1. Open the Processed CSAMT tab and select the sites, from the list or map and click **Editor** button
2. Create a new **Workbench** and define a name
3. Review the data and reject the stacks that are affecting the results by clicking **Reject Stack** button. Rejected stacks will appear in red
4. Review the results on the Amplitude/phase plot
5. The stack can be restored using the **Accept Stack** button

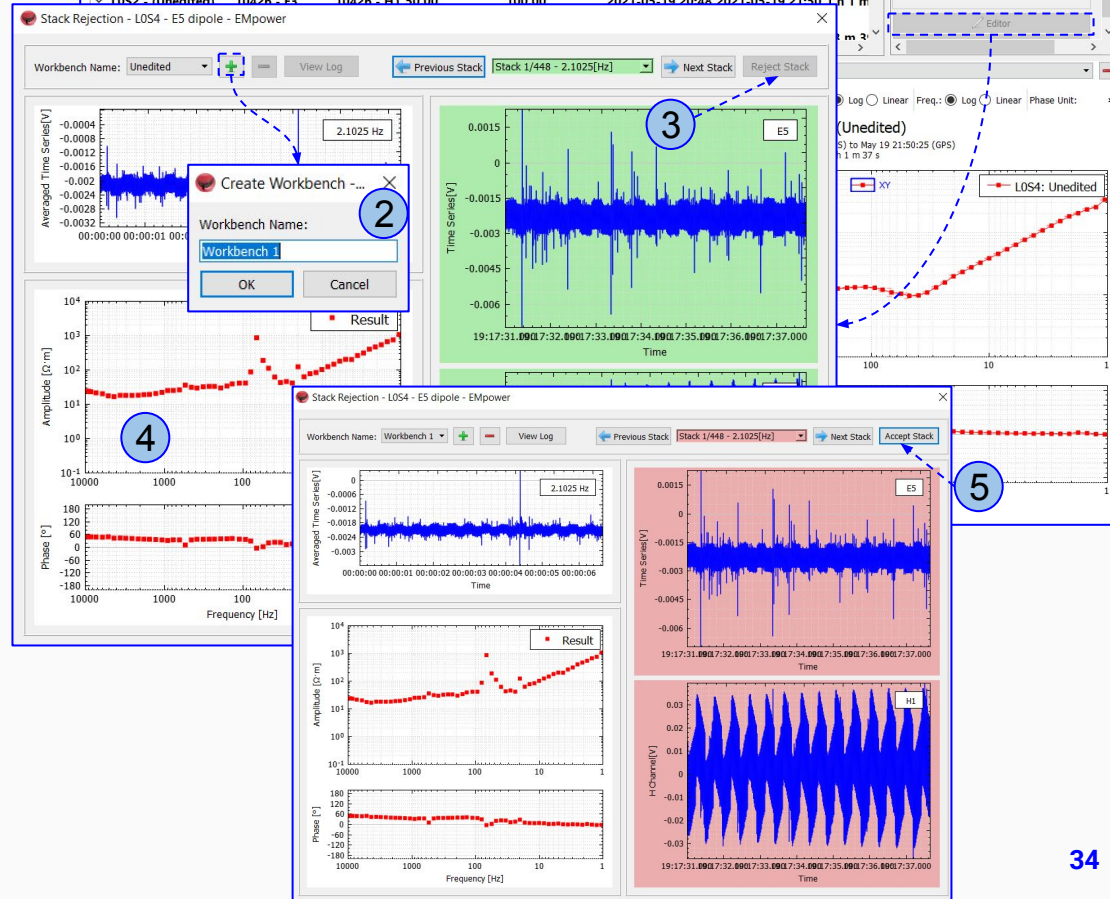

# CSAMT Processed Data Exporter

## 1. Select the **CSAMT** site

- Choose the site from the list or map
- \*EMpower is limited to exporting a single workbench per site*

## 2. Select the **Export CSAMT processed sites** from **File** menu or click **Export Selected** button

- The information will be exported to CSV format

CSAMT FIELD TEST1\_MAY2021 (Z:/CSAMT FIELD TESTS/CSAMT FIELD TEST1\_MAY2021) - EMpower

File Tools View Settings Window Help

Create New Project Ctrl+N  
Open Existing Project Ctrl+O  
Recent Projects...  
Import Recordings Ctrl+I  
Import Calibration Files Ctrl+L  
Import Processed Data Ctrl+R  
Export Recordings Ctrl+E  
Export MT Processed Sites  
Export CSAMT Processed Sites  
Close Current Project Ctrl+W  
Exit Alt+F4

Status	H Channel	Station Offset [m]	Dipole Length [m]	Start Date (GPS)	End Date (GPS)	Duration
	10426 - H1	50.00	100.00	2021-05-12 16:02:20	2021-05-12 16:20:17	17.97
	10426 - H1	100.00	100.00	2021-05-12 16:02:20	2021-05-12 16:20:17	17.97
	10426 - H1	100.00	20.00	2021-05-12 16:02:20	2021-05-12 16:20:17	17.97

Projection: Web Mercator  
WorldMap

5299500  
5299000  
5298500  
5298000

8834500 8834000 8833500 8833000

©OpenStreetMap contributors, SRTM Tiles courtesy of: © OpenTopoMap(CC-BY-SA)

500m

LOS4

CSAMT Process Site Exporter - EMpower

Target Sites

LOS4 - Workbench 1

Exporting Format

Sites with metadata (CSV)

OK Cancel

Amplitude

10<sup>0</sup>

10<sup>-1</sup>

10000 1000 100 10 1

Phase [°]

180  
120  
60  
0  
-60  
-120  
-180

10000 1000 100 10 1

Frequency [Hz]

LOS4: Unedited



## Appendix table of error codes -TXU-30

Remote Control Panel .....	37
Controls used to clear error conditions -TXU-30 .	38
Error codes -TXU-30 .....	40
Troubleshooting TXU-30 - Error 21 .....	43

# Remote Control Panel -TXU-30

The transmitter software constantly monitors the state of the TXU-30. If a fault is detected, the error code will be displayed and corresponding FAULTS LED will light up.

Possible fault conditions:

Faults	Meaning
CH	Current High
CL	Current Low
OVH	Output Voltage High
OVL	Output Voltage Low
CLR	Reset required; press the Clear button
TEMP	Temperature out of range
IGBT	Isolated Gate Bipolar Transistor fault
IVH	Input Voltage High
IVL	Input Voltage Low
SW	Software fault

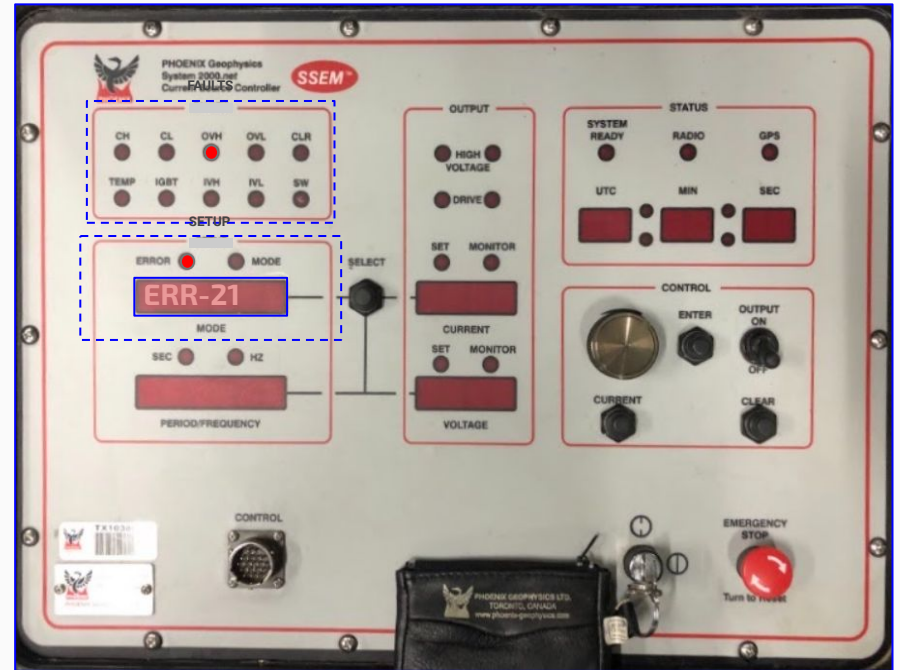

\* Consult the [pages titled "Error codes -TXU-30"](#) for the procedure to clear each error condition

\* Consult next page for a visual map of the controls that might be needed to clear error conditions

# Controls used to clear error conditions -TXU-30

The following pages display the locations of controls in the TXU-30 system referenced in the error code table for troubleshooting purposes (See pages titled "Error codes -TXU-30").

1. Fault lamps
2. Error display
3. OUTPUT switch
4. CLEAR button
5. Emergency Stop switch
6. RESET button

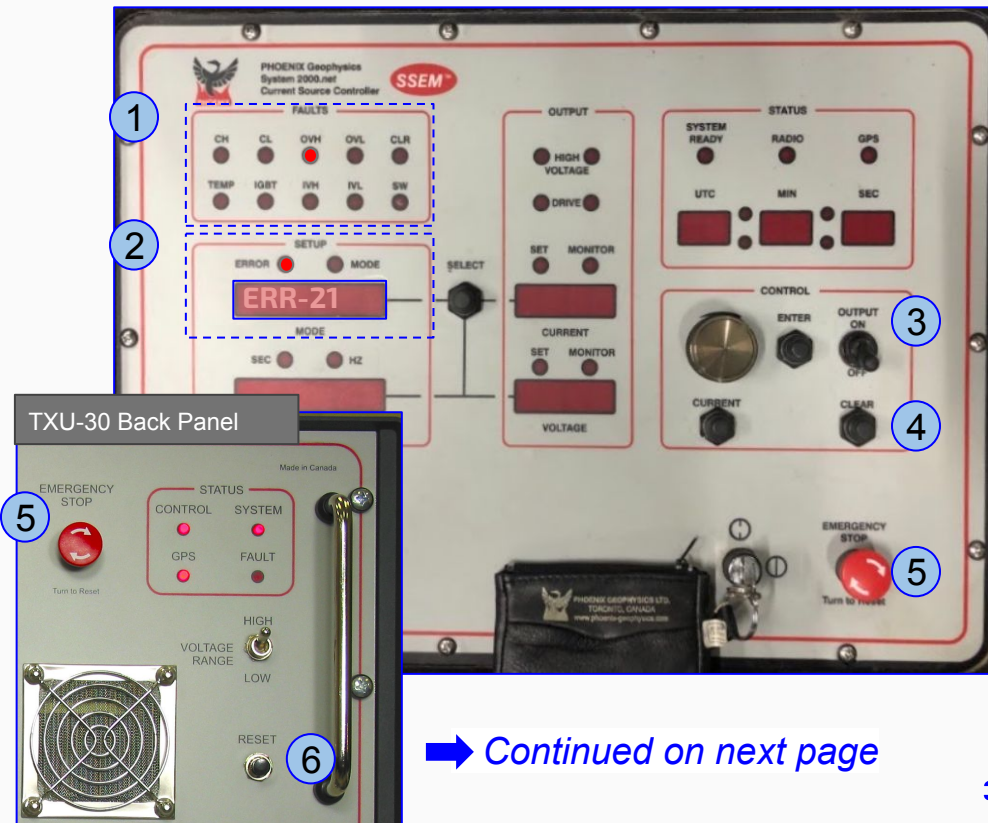

➔ Continued on next page

# Controls used to clear error conditions -TXU-30

- 7. 3 phase power source cable
- 8. TXD-1 cable
- 9. Fans
- 10. Remote controller cable

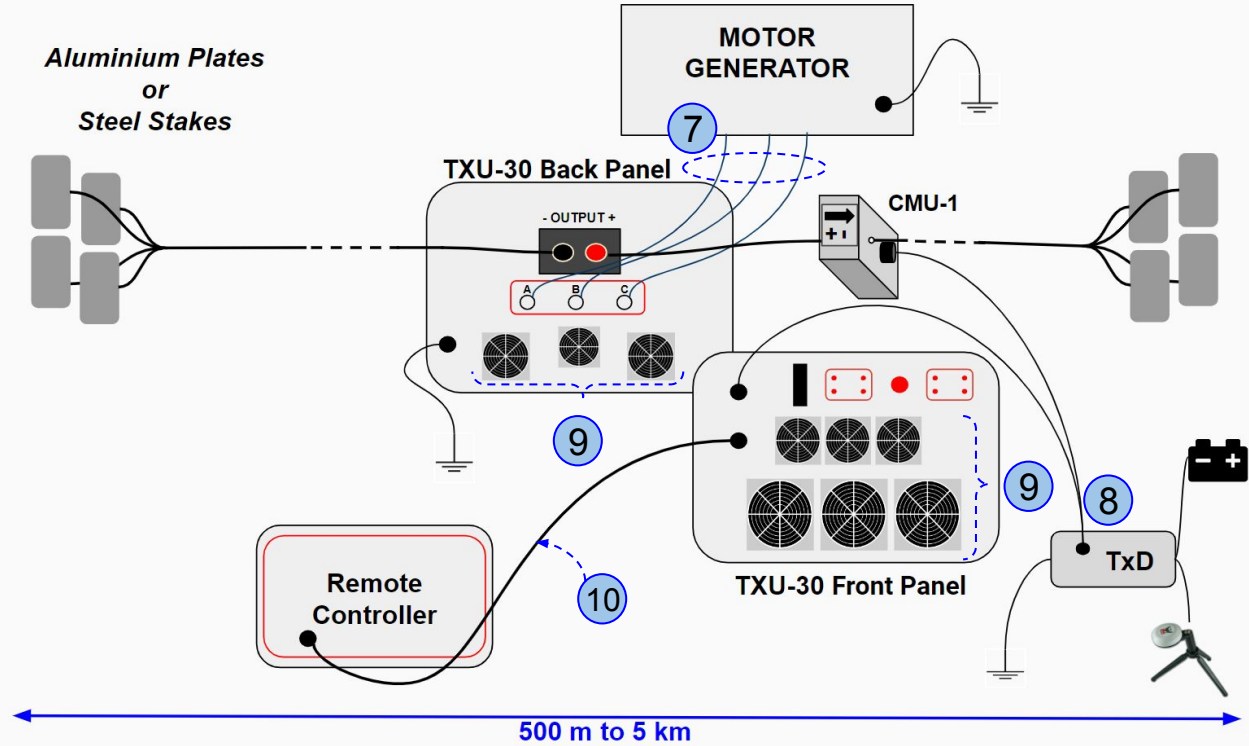

# Error codes -TXU-30

Display	Fault LED	Meaning	Resolution
ERR-01	CLR	Fault (one or more other fault conditions have occurred)	Toggle the OUTPUT switch OFF Press the CLEAR or RESET button
ERR-02	CLR	One or both EMERGENCY STOP buttons were pressed	Toggle the OUTPUT switch OFF Reset the EMERGENCY STOP button(s) Press the CLEAR or RESET button
ERR-03	TEMP	TXU-30 temperature is too high or thermostat has malfunctioned	Toggle the OUTPUT switch OFF Ensure that ventilation openings are unobstructed and that all nine fans are operating Press the CLEAR or RESET button If error recurs, contact Phoenix
ERR-04	CLR	Remote Controller cable malfunction (hardware)	Toggle the OUTPUT switch OFF Ensure that the cable between the TXU-30 and the Remote Controller is properly connected at both ends, and is not damaged Press the CLEAR or RESET button
ERR-05	SW	Software error	Toggle the OUTPUT switch OFF Press the CLEAR or RESET button
ERR-06	CLR	The TXU-30 is under external clock control, but no controlling signal has been detected	Toggle the OUTPUT switch OFF Ensure the cable that goes between the TXU-30 and the TXD-1 is properly connected at both ends. Also check the settings of the external clock control Press the CLEAR or RESET button
ERR-07	IGBT	Internal fault	Turn off the TXU-30 and Contact Phoenix
ERR-08	IGBT	Internal fault	Turn off the TXU-30 and Contact Phoenix
ERR-09	IGBT	Internal fault	Turn off the TXU-30 and Contact Phoenix
ERR-10	IGBT	Internal fault	Turn off the TXU-30 and Contact Phoenix



# Error codes -TXU-30

Display	Fault LED	Meaning	Resolution
ERR-11 to 14	-	Not Used	
ERR-15	IVH	Input voltage too high; probably a fault in 3-phase source	Toggle the OUTPUT switch OFF At the 3-phase power source, check the voltage across phases A-B and A-C. The values must be no greater than 240V
ERR-16	IVL	<ul style="list-style-type: none"> <li>Input voltage too low; likely fault in 3-phase source.</li> <li>In Model TAB02, if the transformer overheats this can also raise ERR-16.</li> </ul>	Toggle the OUTPUT switch OFF At the 3-phase power source, check the voltage across phases A-B and A-C. The values must be at least 208V  If the voltage is within the correct range, allow the fans to cool the TXU-30 before starting it again. If the error persists, the transmitter may be damaged. Contact <a href="#">Phoenix Support</a>
ERR-17/18	-	Not Used	
ERR-19	CH	Output current too high	Toggle the OUTPUT switch OFF and press the CLEAR or RESET button Then reduce the requested current, or increase the load impedance
ERR-20	CL	Output current too low	Toggle the OUTPUT switch OFF and press the CLEAR or RESET button Then increase the requested current, or decrease the load impedance
ERR-21	OVH	Output voltage too high (>550V or >1100V)	Toggle the OUTPUT switch OFF and press the CLEAR or RESET button Then reduce the requested current. For more details, see pages titled "Troubleshooting TXU-30 - Error 21"
ERR-22	OVL	Output voltage too low (<25V)	Toggle the OUTPUT switch OFF and press the CLEAR or RESET button Then increase the requested current or increase the load impedance
ERR-23	-	Not Used	
ERR-24	SW	TXU was powered on with controller OUTPUT switch ON	Toggle the OUTPUT switch OFF and press the CLEAR or RESET button

# Error codes -TXU-30

Display	Fault LED	Meaning	Resolution
ERR-25	SW	Selected frequency is out of range for selected waveform	Toggle the OUTPUT switch OFF and press the CLEAR or RESET button Select an appropriate frequency. In auto modes, check the contents of the frequency table. In external clock mode, check the TXD-1 and connections
ERR-26	SW	VOLTAGE RANGE switch was changed while the OUTPUT switch was toggled ON	Toggle the OUTPUT switch OFF and press the CLEAR or RESET button
ERR-27	SW	Main power contacts inoperable. If this fault occurs during shutdown, the main power relay may have failed	Toggle the OUTPUT switch OFF At the 3-phase power source, check the voltage across phases A-B and A-C. The values must be between 208V and 240V Press the CLEAR or RESET button If the values are within range or the fault occurs during shutdown, contact Phoenix
ERR-28	SW	Output power exceeds transmitter rating	Toggle the OUTPUT switch OFF and press the CLEAR or RESET button Then reduce the requested current
ERR-29	-	Not Used	
ERR-30	-	Not Used	
ERR-31	CLR, CONTROL	Remote Controller cannot communicate with TXU-30	It is normal to see this error message briefly if the remote controller and the TXU-30 are both powered on at the same time. The remote controller finishes booting up before the TXU-30 does, and can not communicate with it, triggering the fault indication. It is also normal to see this error message during a software update when the system reboots. If the error occurs under these conditions, it will clear itself when the TXU-30 finishes booting up and communication is established. If this fault occurs under other conditions, ensure that the cable between the TXU-30 and the remote controller is properly connected at both ends and is not damaged. Press the CLEAR or RESET button.

# Troubleshooting TXU-30 - Error 21

This error indicates that the voltage at the output of the TXU-30 is too high ( $>550V$  for 500V mode, or  $>1100V$  for 1000V mode).

This is usually caused by transmitting high current at high frequencies. Depending on the wire type, length and layout used for the transmitting dipole, the dipole may present high impedance at high frequencies, causing energy reflections that can cause the TXU-30 to trip with "ERROR-21".

The best way to solve this problem is to skip the frequency that causes the problem (see [Slide 5: Frequency Transmission Schedule](#)) or reducing any undesired reactance in the transmitting dipole.

- Ensure that the dipole is laid out only with the necessary amount of wire, so that there is no excess wire coiled up. A coiled up segment of wire will increase impedance at high frequencies. Even a large segment of wire laid out in S-shapes causes an increase in inductance, so it is advisable to use just the wire necessary to set up the transmitting dipole, allowing for some slack. Using a thicker wire can also reduce the impedance.

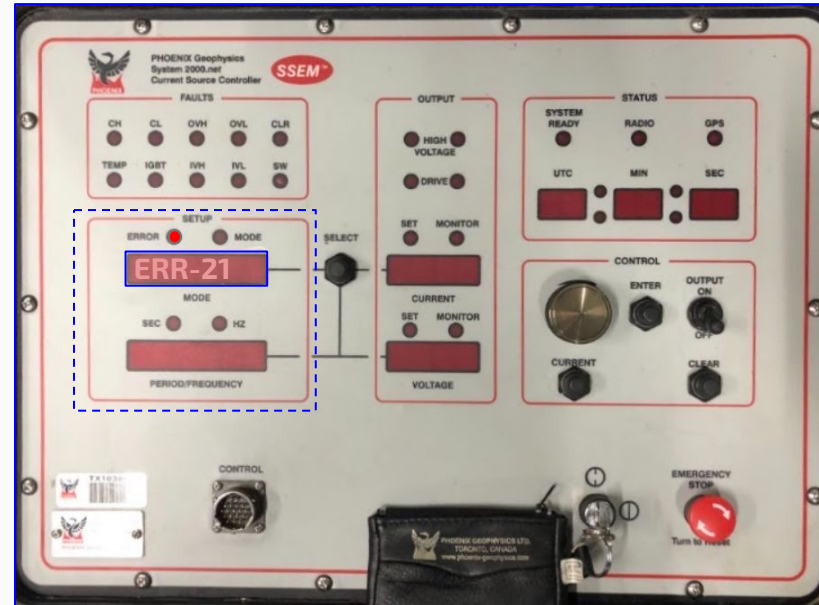

# Troubleshooting TXU-30 - Error 21 - Continued

If your dipole is already using an optimal length of wire, to prevent Error 21 from happening, the current can be manually reduced before reaching the high frequencies which cause the TXU-30 to report ERROR 21 by using the following procedure:

1. During transmission observe the frequency being transmitted in the remote controller. When the schedule approaches higher frequencies push and hold the current button
2. Reduce the current using the dial

After the frequencies that cause tripping have passed in the transmission cycle (*as seen in the remote controller*), increase the transmitted current to the desired value by following steps **1** and **2** above

**TXU-30 Remote control panel**

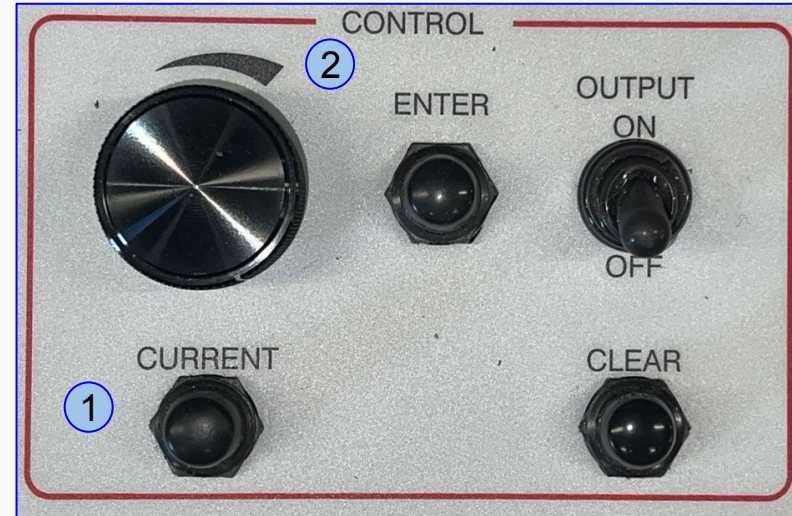

# Troubleshooting TXU-30 - Error 21 - Continued

If you have attempted the solutions previously provided, and this problem keeps occurring, you can attempt resetting the error 21 manually every cycle.

To do this:

- A.** As soon as the error appears during a transmission, toggle the output switch from the the Remote Control to OFF
- B.** Press the CLEAR button (In older units the button will read RESET instead)
- C.** Reduce the requested current as explained in steps **1** and **2** in the previous slide
- D.** Toggle OUTPUT switch back ON to start transmitting as soon as the next frequency comes up in the display.

**TXU-30 Remote control panel**

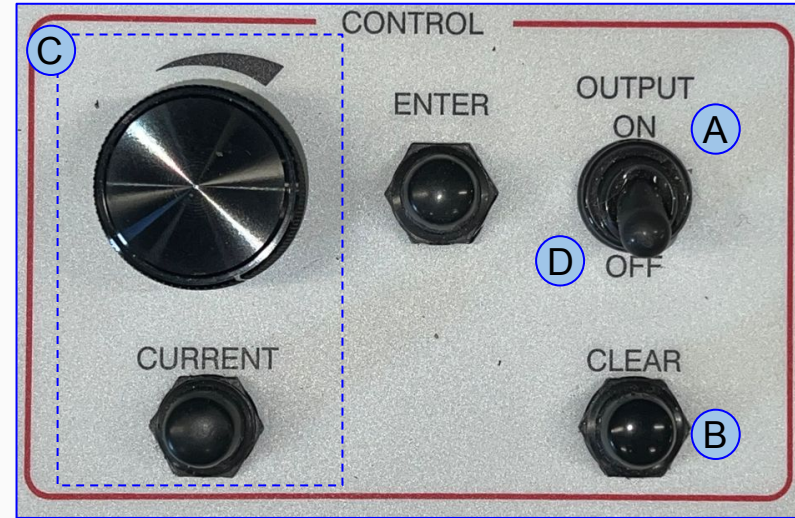



*Please check out the [FAQs](#)*

*<https://phoenixgeophysics.freshdesk.com/>*

*Or email us at: [support@phoenix-geophysics.com](mailto:support@phoenix-geophysics.com)*